

Estante Vira e Mexe

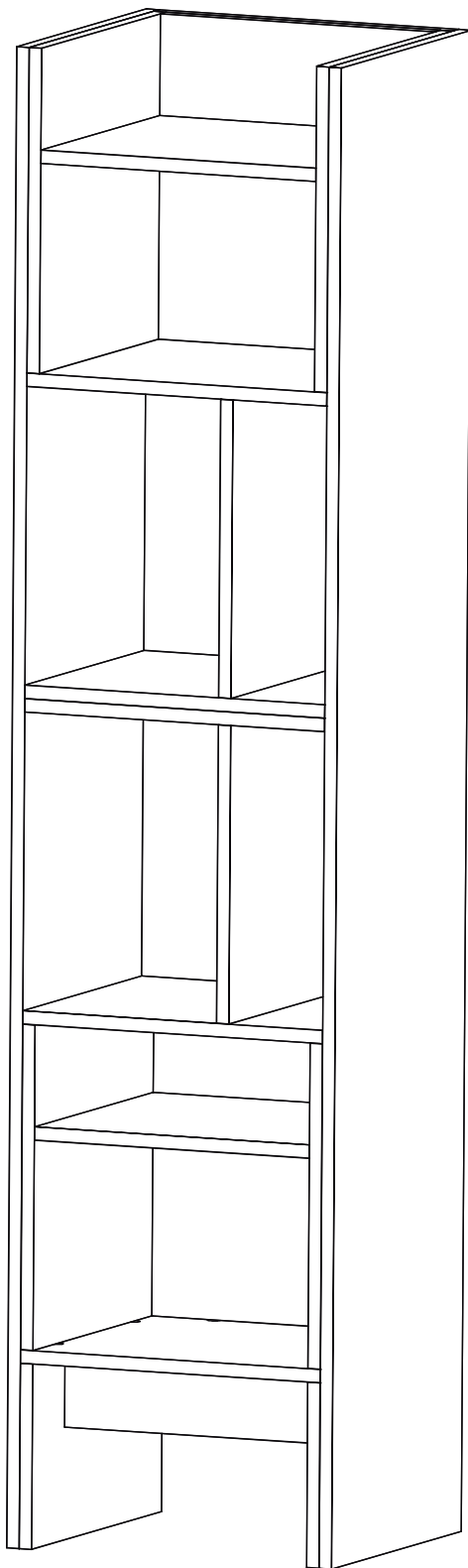

Veromobili



Ler e observar atentamente todas as instruções antes de iniciar a montagem, A montagem do produto deverá ser feita em uma superfície limpa e plana.

Aconselhamos utilizar a embalagem para forrar o chão a fim de não danificar o produto.

Nos produtos verificar as numerações gravadas nas peças para a montagem correta do móvel.

Limpeza

Madeira

Para a limpeza do seu móvel, utilize somente sabão neutro e um pano levemente umedecido.

Dê preferência para panos brancos isso evitar manchas no produto.

Na limpeza diária, não utilizar produtos abrasivos, como palhas de aço, esponja de lã de aço, álcool, saponáceo ou outros que possam riscar ou descolar a camada protetora. Durante a limpeza, deixe o ambiente bem arejado.

Dobradiças e corrediças

Utilizar para a limpeza um pano macio ou pincel de cerdas suave para remover a poeira.

Evitar contato com produtos como sal, limão e vinagre. Eles podem acelerar a oxidação dos acessórios metálicos.

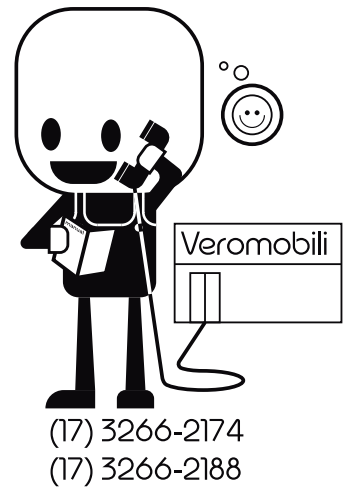
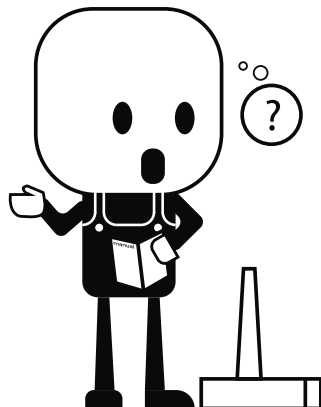
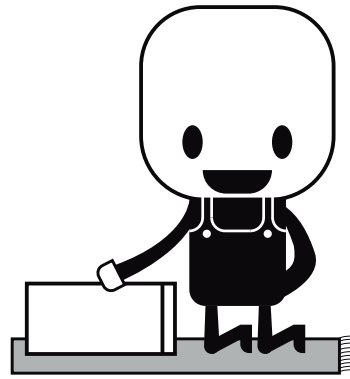
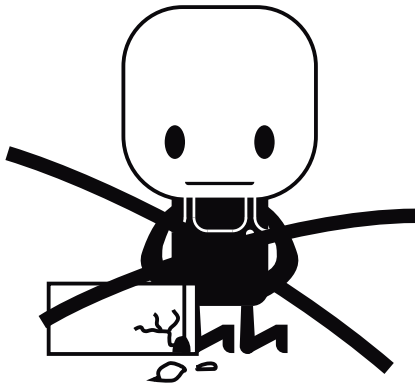
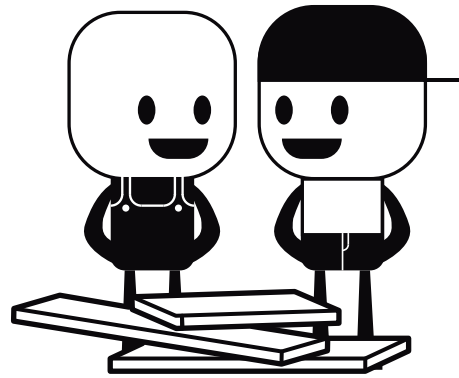
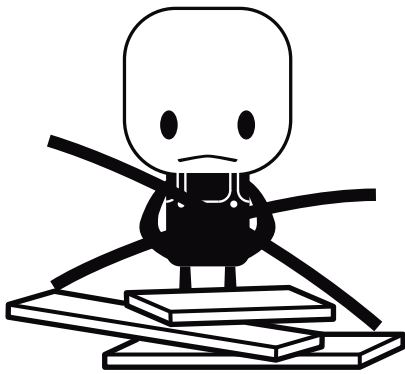
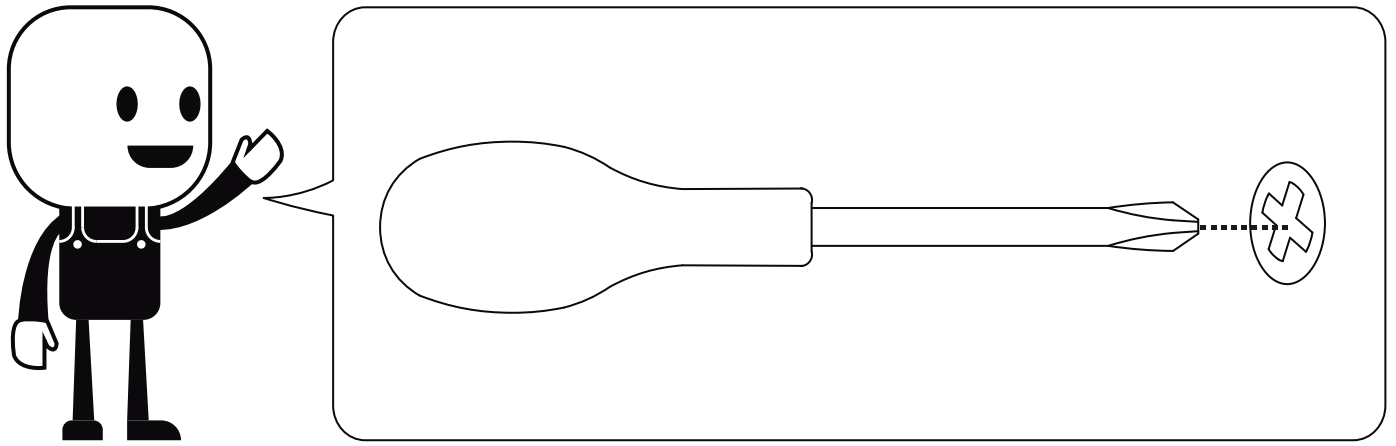

A  **16x**
Haste Rodofix

C  **16x**
Tambor Rodofix

B  **12x**
Cavilha

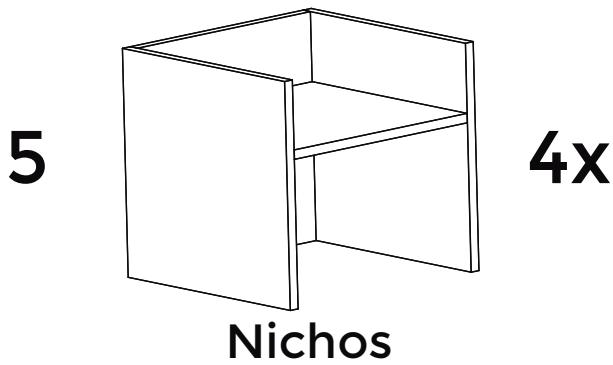
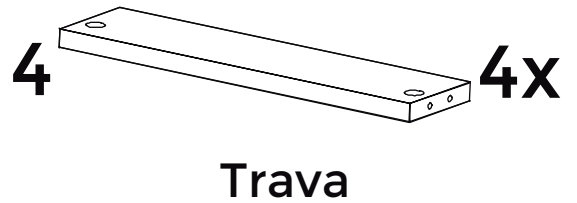
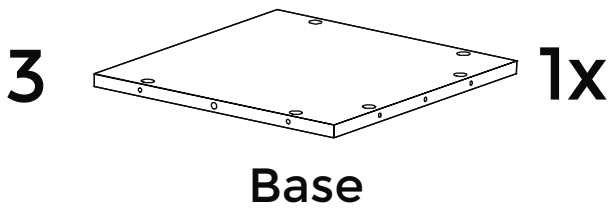
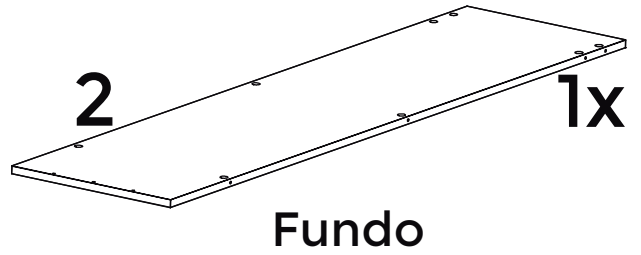
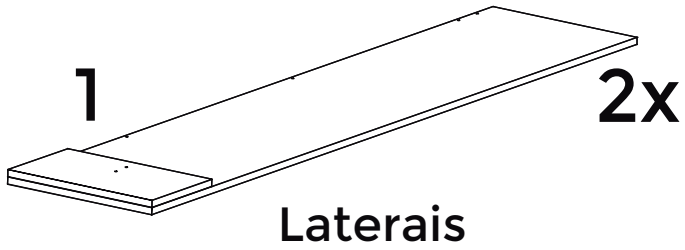

MONTAGEM DA ESTANTE

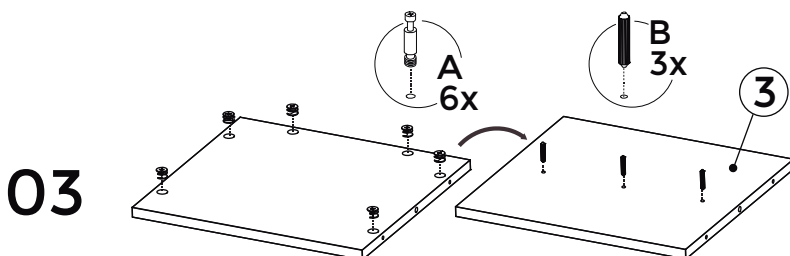
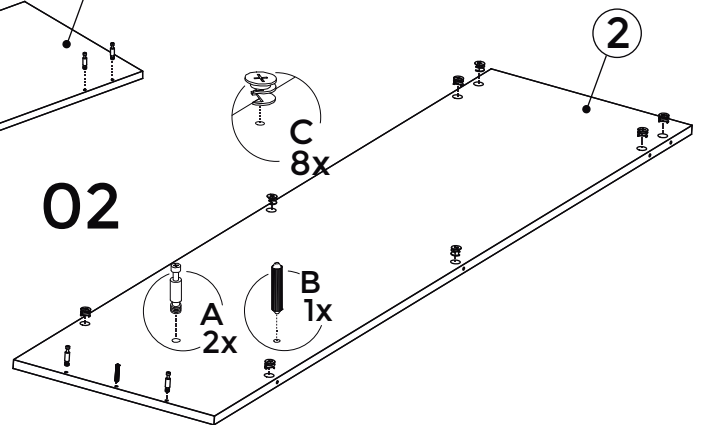
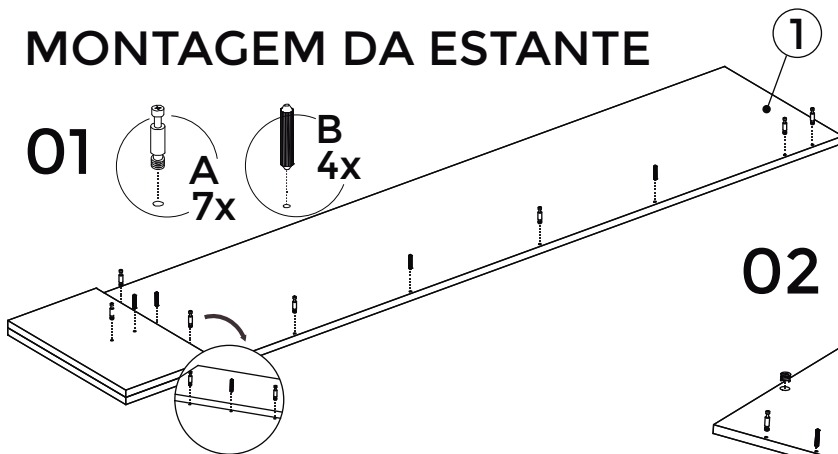

04

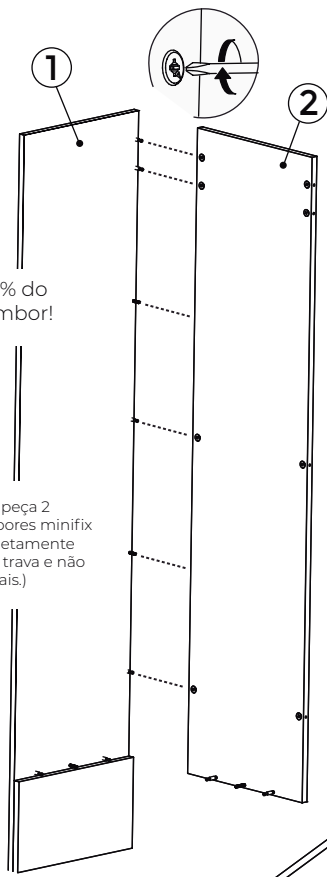

Atinja 100% do giro do tambor!

Una a peça 1 à peça 2 rosqueando os tambores minifix (ele só está completamente rosqueado quando trava e não rosqueia mais.)

05

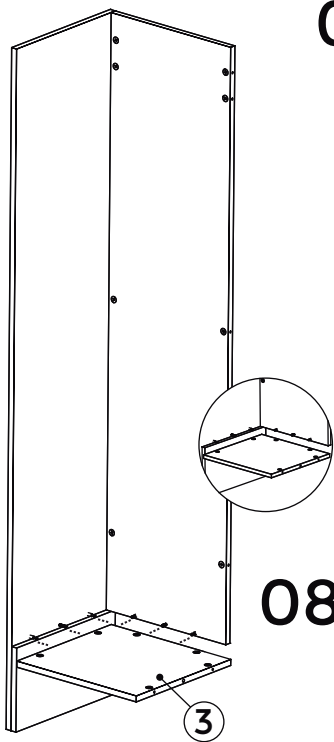

06

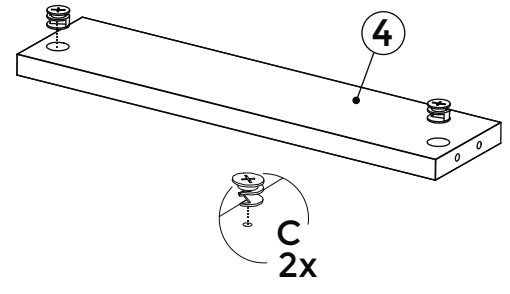

08

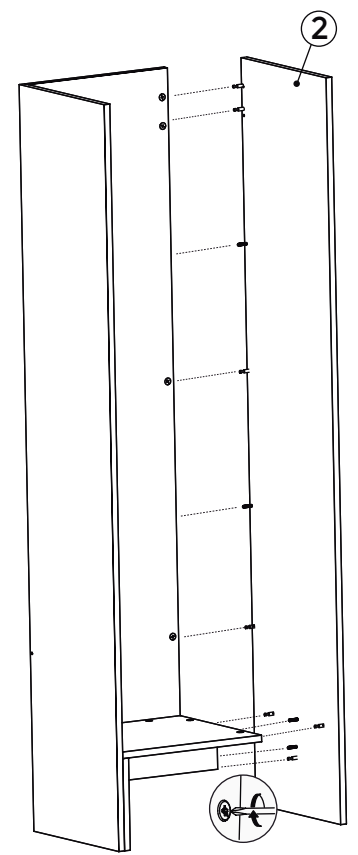

07

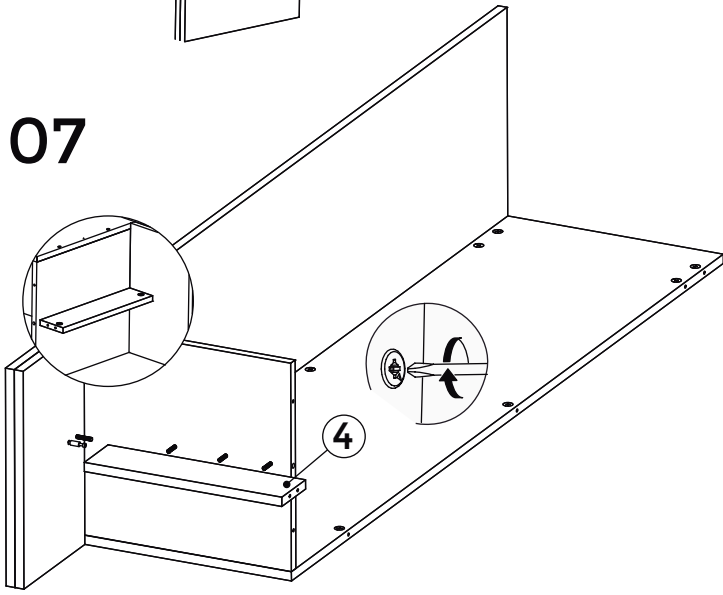

10

09

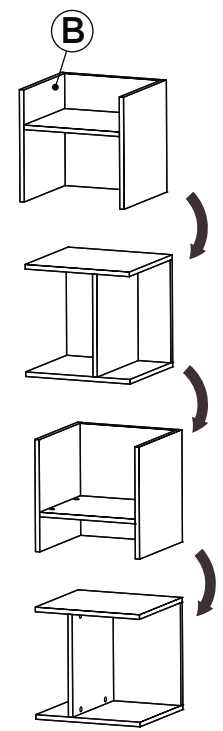
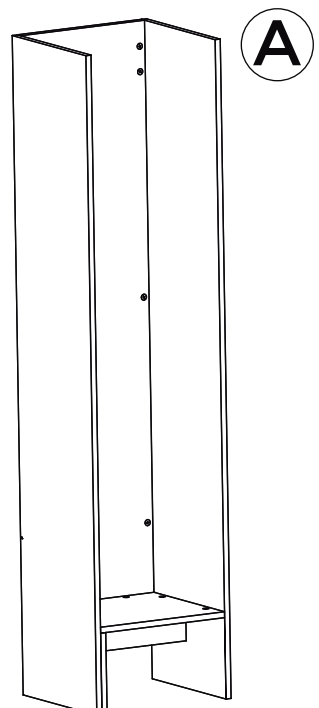

Os nichos podem ser colocados em várias posições! Use a sua imaginação :)

PESO MÁX. NICHOS 5KG*